



U.S. Department  
of Transportation  
**Federal Aviation  
Administration**

**AC 20-37E**  
**Date: 9/9/05**

# ADVISORY CIRCULAR



## **AIRCRAFT PROPELLER MAINTENANCE**

Flight Standards Service  
Washington, D.C.

---

**Initiated By: AFS-350**



U.S. Department of  
Transportation  
**Federal Aviation  
Administration**

# Advisory Circular

---

**Subject: AIRCRAFT PROPELLER  
MAINTENANCE**

**Date: 9/9/05**

**AC No: 20-37E**

**Initiated By: AFS-350 Change:**

---

**1. PURPOSE.** This advisory circular (AC) provides information and describes maintenance procedures for owners, operators, and Federal Aviation Administration (FAA)-certificated maintenance personnel during the service life of aircraft propellers. It further recommends minimum requirements for propeller field maintenance and provides a checklist for propeller annual inspection.

**2. CANCELLATION.** This AC cancels AC 20-37D, Aircraft Propeller Maintenance, dated 8/15/89.

**3. PRINCIPAL CHANGES.** This AC has been updated to provide more current guidance for inspection, maintenance, and field repair of aircraft propellers. Propellers of all types are covered, including propellers of composite, wood, and metal. Inspection and maintenance methods contained within should be used where guidance is otherwise unavailable.

**4. RELATED READING MATERIAL.** Manufacturers' instructions for continued airworthiness, service bulletins, maintenance records, and airworthiness directives are the primary documents containing information relating to the care and maintenance of propellers. In addition, AC 43.13-1, Acceptable Methods, Techniques, and Practices - Aircraft Inspection and Repair, current edition, and AC 43-4, Corrosion Control for Aircraft, contain many references to propeller inspection and maintenance, current edition.

**NOTE: These ACs may be downloaded free of charge from the following FAA public Web site: [http://www.faa.gov/regulations\\_policies/](http://www.faa.gov/regulations_policies/).**

**5. DISCUSSION.** When properly maintained, propellers are designed to operate safely in a high-stress environment for extended periods of time. However, despite the design factors engineered into propellers, failures continue to occur. FAA data on propeller failures indicate that failures occur across the entire spectrum of aircraft engine-propeller combinations. The propeller maintenance information contained in this AC provides maintenance personnel with information and techniques to reduce these failures and increase propeller service life. Because of the age of some propeller systems, original guidance and instructions for maintenance, service, and overhaul may not have been updated (e.g., if the manufacturer is no longer in

---

business) with improved techniques. Accordingly, this AC is intended to provide supplementary guidance on propeller maintenance and service methods when such guidance is lacking from the manufacturer or is not consistent with current practice.

/s/ John M. Allen (for)  
James J. Ballough  
Director, Flight Standards Service

## CONTENTS

	<i>Page</i>
<b>CHAPTER 1. DESIGN DAMAGE AND FAILURES</b>	
100. Propeller Major Repair and Overhaul.....	1
101. Propeller Design and Causes of Failure.....	1
102. Types of Propeller Damage .....	1
Figure 1-1. Hub Surface Corrosion.....	2
Figure 1-2. Polished Blade Surface Corrosion .....	2
Figure 1-3. Pitting .....	2
Figure 1-4. Pitting on a Shot Peened Surface .....	2
Figure 1-5. Exfoliation on the Blade Leading Edge .....	3
Figure 1-6. Blade Nick.....	4
Figure 1-7. Erosion on a Metal Blade.....	4
Figure 1-8. Hub Crack .....	4
Figure 1-9. Blade Crack from a Nick.....	4
Figure 1-10. Lightning Strike on a Metal Blade Tip .....	5
Figure 1-11. Strong Lightning Strike on a Composite Blade Tip.....	5
Figure 1-12. Lightning Strike on a Composite Surface .....	5
Figure 1-13. Propeller Blade Struck by a Foreign Object .....	6
<b>CHAPTER 2. MAINTENANCE AND OVERHAUL</b>	
200. Requirements for Maintenance and Overhaul .....	7
201. Cleaning .....	8
Figure 2-1. Grease Leak Residues .....	9
202. Inspection Methods.....	9
203. Types of Inspection.....	10
Figure 2-2. Propeller Tracking (Wood Block or Cowling Fixture Shown).....	12
204. Inspection Levels .....	13
Figure 2-3. Heater Edge Debond .....	15
Figure 2-4. Sheath Crack .....	15
205. Limitations .....	20
206. Procedures for Maintenance .....	21
Table 2-1. Blade Leading Edge Repair.....	24
Figure 2-5. Techniques for Blade Repair.....	25
Figure 2-6. Composite Blade Erosion.....	26
<b>CHAPTER 3. ACCESSORIES AND BALANCING</b>	
300. Propeller Balancing.....	27
Figure 3-1. Balance Tape that was not Removed .....	29
301. Tachometer Inspection.....	29
302. Governors, Feathering, and Reversing Mechanisms .....	29
303. Propeller De-Icers .....	30

**CHAPTER 4. INSTALLATION**

400. Propeller Installation.....31

**APPENDIX 1. GLOSSARY OF COMMON PROPELLER TERMS (3 Pages).....1**

## CHAPTER 1. DESIGN DAMAGE AND FAILURES

**100. PROPELLER MAJOR REPAIRS AND ALTERATIONS.** Major repairs or alterations are only permitted within the context of this document or when a propeller manufacturer's data approves that major repair or alteration. Only an appropriately rated repair station may accomplish major repairs or alterations. Refer to Title 14 of the Code of Federal Regulations (14 CFR) part 43, Appendix A, for identification of major alterations and repairs to propellers.

### 101. PROPELLER DESIGN AND CAUSES OF FAILURE.

**a.** A propeller is one of the most highly stressed components on an aircraft. During normal operation, 10 to 25 tons of centrifugal force pull the blades from the hub while the blades are bending and flexing due to thrust and torque loads and engine, aerodynamic and gyroscopic vibratory loads. A properly maintained propeller is designed to perform normally under these loads, but when propeller components are damaged by corrosion, stone nicks, ground strikes, etc., an additional unintended stress concentration is imposed and the design margin of safety may not be adequate. The result is excessive stress and the propeller may fail.

**b.** Additional causes of overstress conditions are exposure to overspeed conditions, other object strikes, unauthorized alterations, engine problems, worn engine vibration dampers, lightning strike, etc. Most mechanical damage takes the form of sharp-edged nicks and scratches created by the displacement of material from the blade surface and corrosion that forms pits and other defects in the blade surface. This small-scale damage tends to concentrate stress in the affected area and eventually, these high-stress areas may develop cracks. As a crack propagates, the stress becomes increasingly concentrated, increasing the crack growth rate. The growing crack may result in blade failure.

**102. TYPES OF PROPELLER DAMAGE.** Many types of damage cause propellers to fail or become unairworthy. FAA data on propeller failures indicates that the majority of failures occur in the blade at the tip region, usually within several inches from the tip and often due to a crack initiator such as a pit, nick, or gouge. However, a blade failure can occur along any portion of a blade, including the mid-blade, shank, and hub, particularly when nicks, scratches, corrosion, and cracks are present. Therefore, during propeller inspection and routine maintenance, it is important to inspect the entire blade. The severity of the damage determines the type of repairs required. Additional guidance on damage is given in manufacturers' service documents, Chapter 2, paragraph 205, of this AC, and AC 43.13-1, current edition. The following paragraphs describe some of the types of damage that may be found in propellers.

**a. Corrosion.** One of the principal causes of loss of airworthiness in propellers is corrosion. External corrosion on metal blades, hubs, and other components poses a serious problem. Internal corrosion may exist where moisture may collect in internal cavities such as hubs, blade clamps, and pitch control mechanisms. This threatens propeller structural integrity and performance without being noticed. The overhaul calendar time periods for propellers are established so that the propeller can be disassembled to inspect internal surfaces. Moreover, corrosion acts continuously, regardless of the actual time in operation. Corrosion on metal propeller components can be classified into three distinct types.

(1) **Surface Corrosion.** The loss of surface metal due to chemical or electro-chemical action with visible oxidation products usually having a contrasting color and texture to the base metal. Surface corrosion, as shown in Figures 1-1 and 1-2, generally results when the corrosion protection on a metal surface has been removed by erosion or by polishing. Therefore, removing paint and corrosion protection, such as when polishing blades, is not recommended.

**FIGURE 1-1.  
Hub Surface Corrosion**



**FIGURE 1-2.  
Polished Blade Surface Corrosion**



(2) **Pitting.** Pits consist of visible corrosion cavities extending inward from the metal surface. They can grow on the surface, under decals, or under improperly installed de-ice boots. Pitting can appear to be relatively minor - 0.010 inches deep - and still cause major problems since the pits could be a precursor to the initiation of cracks (see Figures 1-3 and 1-4).

**FIGURE 1-3.  
Pitting**



**FIGURE 1-4.  
Pitting on a Shot Peened Surface**

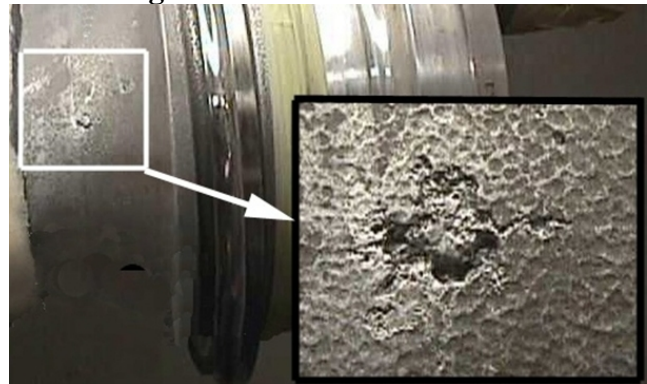

(3) **Intergranular Corrosion.** Occurs in grain boundaries. The presence of intergranular corrosion may be the result of the continued presence of moisture such as under a decal, in a fastener hole, or where the anodize and paint protective barriers have been lost. Exfoliation is a form of intergranular corrosion that occurs more often in forgings or rolled

sheets, and less often in castings. Exfoliation is sometimes visible as metal flaking and cracks on a blade leading edge (see Figure 1-5).

**FIGURE 1-5.**  
**Exfoliation on the Blade Leading Edge**



**b. Face, Leading Edge, or Twist Misalignment.** When propeller blades are bent, twisted, or cocked, they will not be properly aligned with each other in operation. This will cause vibration and may cause a loss of thrust. The level of vibration can be severe and depending on the severity of the misalignment, could lead to catastrophic failure (see Chapter 2, paragraph 203a).

**c. Nick.** A sharp, notch-like displacement of metal usually found on leading and trailing edges. All nicks are potential crack starters (see Figure 1-6).

**d. Erosion.** The loss of material from blade surface by the action of small particles such as sand or water and is usually present on the leading edge close to the tip. This damage destroys the blades' corrosion protection, which might lead to blade failure (see Figure 1-7).



**FIGURE 1-6.  
Blade Nick**

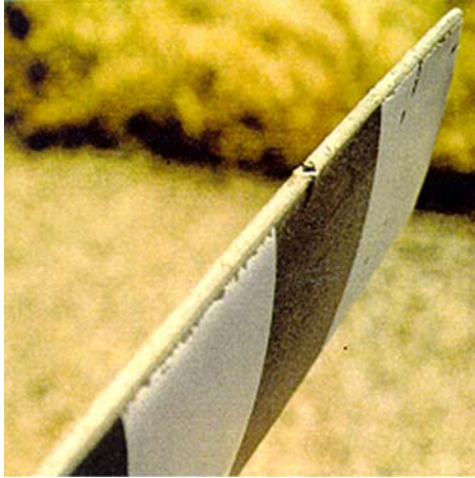

**FIGURE 1-7.  
Erosion on a Metal Blade**



**e. Scratches, Gouges, Cuts, and Scoring.** These terms describing surface damage are found in Appendix 1, Glossary of Common Propeller Terms.

**f. Cracks.** When found anywhere in a propeller, cracks are cause for its immediate removal and detailed inspection. Cracks in propellers will grow over time, perhaps very rapidly, and eventually lead to failure (see Figures 1-8 and 1-9).

**FIGURE 1-8.  
Hub Crack**



**FIGURE 1-9.  
Blade Crack from a Nick**



**g. Dents.** Dents can be harmful, depending on their size, location, and configuration. Dents cause local stress risers around their perimeter and at the bottom under the surface. Removing material should repair dents. Filling dents with any material such as auto body compound does nothing to correct the stress riser and is not approved. Failure may occur.

**h. Lightning Strike.** A lightning strike on a metal blade may be indicated by a small burned and melted area on the blade, a trail of small pits along the blade, or may show no indication at

all (see Figure 1-10). However, the damage from a lightning strike may be severe, affecting the strength of the blade material itself, damaging blade bearings or other internal components. Lightning always creates residual magnetism in steel parts. Inspection for damage from a reported lightning strike may require specialized equipment, like a gauss meter, to check for magnetism in steel components, and should be accomplished by an appropriately rated propeller repair station. A lightning strike on a composite blade may be indicated by small burnt areas on the composite where the lightning may have attached or exited (see Figure 1-11 or 1-12). Composite blades may suffer other damage as well. Refer to the propeller manufacturer's maintenance manual for diagnosis and corrective action.

**FIGURE 1-10.**  
**Lightning Strike on a Metal Blade Tip**

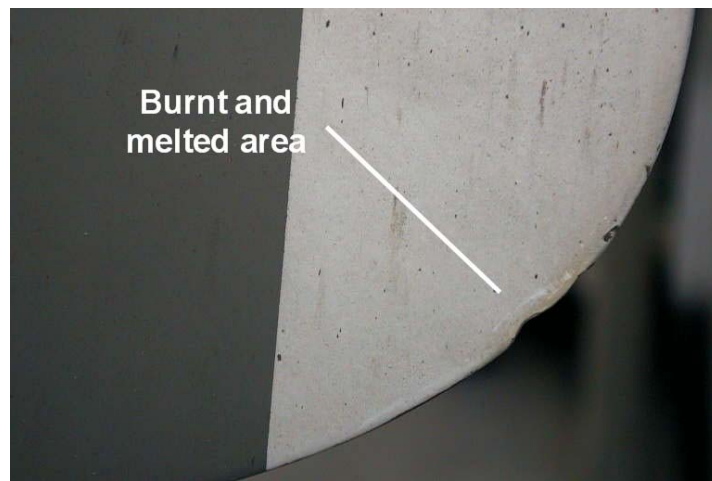

**FIGURE 1-11.**  
**Strong Lightning Strike on a Composite Blade Tip**

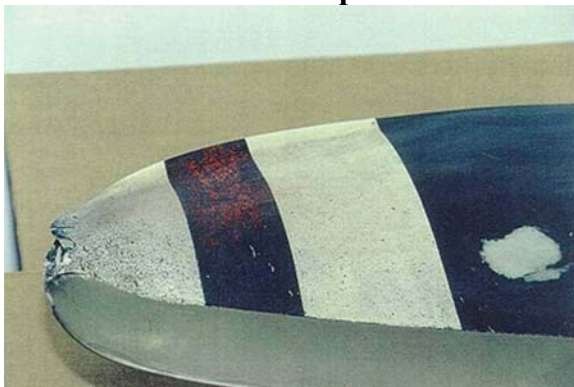

**FIGURE 1-12.**  
**Lightning Strike on a Composite Surface**



**i. Overspeed.** A propeller may have been exposed to an overspeed condition and give no indication of the event. However, the event may have severely damaged the propeller due to the dramatic increase in centrifugal loads. If the propeller is suspected of having been operated in an overspeed condition, it should be removed and sent to a propeller repair station to be inspected

for elongation of boltholes, dimension changes, or other signs of stress in accordance with the appropriate manufacturer's maintenance instructions. Sometimes excessive tolerances in engine or propeller governor settings can permit overspeed conditions into restricted rotational speed ranges without the knowledge of the operator.

**j. Foreign Object Strike.** A foreign object strike can include a broad spectrum of damage, from no visible damage, to a small nick, to severe ground impact damage. A conservative approach in evaluating the damage is required because of the possibility that there may be hidden damage that is not readily apparent during a superficial, visual inspection (see Figure 1-13). Refer to the manufacturer's maintenance instructions for damage limitations.

**FIGURE 1-13.**  
**Propeller Blade Struck by a Foreign Object**



**k. Fire Damage or Heat Damage.** On rare occasions, propellers have been exposed to fire or heat damage such as a hangar or engine fire. In the event of such an incident, an inspection is required before further flight. Such parts are normally retired. If there is any indication or suspicion that aluminum propeller parts have been exposed to high temperatures (in excess of 200 °F (93 °C)), then the parts must be assumed to be unairworthy, unless it can be proven that there have been no adverse effects from the incident. Composite propeller blades may have a lower temperature threshold for potential damage. Refer to the manufacturer's maintenance instructions for this limitation. Confirmation of airworthiness requires complete disassembly and inspection of the propeller by an appropriately rated propeller repair station in accordance with the propeller maintenance manual. Always advise the repair station that the propeller may have been exposed to heat or fire when it is sent in for this type of inspection.

## CHAPTER 2. MAINTENANCE AND OVERHAUL

### 200. REQUIREMENTS FOR MAINTENANCE AND OVERHAUL.

**a. Sources of Propeller Repair Information.** Airworthiness Directives (AD), type certificate (TC) data sheets, manufacturers' manuals, service letters, and bulletins specify methods and limits for propeller maintenance, inspection, repair, and removal from service. When a manufacturer's data specifies that major repairs are permitted to a specific model blade or other propeller component, only an appropriately rated repair facility may accomplish those repairs. An FAA-certificated mechanic with at least a powerplant rating can accomplish all other propeller maintenance and minor repair by using the practices and techniques specified by this advisory circular (AC) and in the propeller manufacturer's service data. Some maintenance and minor repairs in this category are the removal of minor nicks, scratches, small areas of surface corrosion, painting, and minor deicer boot repairs. Because of the complexity of propeller damage and because damage tends to be hidden or not obvious to untrained maintenance personnel, we recommend that propeller damage be referred to experienced repair personnel whenever doubt exists regarding a condition that has been observed. We further recommend that owners/operators follow the manufacturer's maintenance and overhaul program.

**b. Service Personnel Limitations and Responsibilities.** Title 14 of the Code of Federal Regulations (14 CFR) part 65, section 65.81, specifically excludes certificated and rated airframe and powerplant mechanics from performing major repairs and/or major alterations on aircraft propellers. Title 14 CFR part 43, Appendix A, defines major alterations and repairs to propellers. However, 14 CFR part 145, section 145.201, provides that an appropriately rated repair station may perform such major repairs or alterations provided the work is done in accordance with technical data approved by the Administrator. Part 145 also specifies the personnel qualifications and other requirements applicable to propeller repair stations. When complying with ADs, service personnel are required to review all applicable manufacturers' service bulletins (SB), manuals, and other information on the propeller being inspected, overhauled, or repaired, if included by reference.

**c. Periodic Reconditioning of Aluminum Fixed-Pitch Propellers.** A number of factors will require returning a propeller to a propeller repair station for service, repair, or rework. All propeller manufacturers recommend a periodic reconditioning of aluminum fixed-pitch models at specified service time intervals to prevent blade failure from surface damage that may not be visible. This reconditioning requires the propeller to be returned to a repair station for removal of a thin layer of surface metal to remove surface and subsurface damage such as nicks and corrosion. Fatigue cycles generated by some engine/propeller combinations can require manufacturer-reconditioning intervals as often as every 500 hours of operation.

**d. Periodic Overhaul and/or Inspection of Variable Pitch Propellers.** Propeller manufacturers recommend a periodic propeller overhaul or teardown inspection. Some propeller makes and models are required by ADs to be inspected, repaired, or partially disassembled for evaluation. In most cases, such a requirement is a major repair or alteration and dictates that the propeller is returned to a propeller repair station.

**e. Inspection and Maintenance by the Owner/Operator.** Notwithstanding the other requirements stated herein, it is incumbent on the owner/operator to inspect and conduct routine maintenance on his/her propeller. This document and others cited in this AC provide guidelines for doing such maintenance.

**f. Propeller Records.** Maintenance records are a required part of aircraft maintenance. Propeller maintenance recordkeeping responsibility is ultimately assigned to the owner/operator of aircraft operated under 14 CFR part 91 in accordance with part 91, section 91.403. Section 91.417 requires a record of maintenance, including a record of total time in service and time since last overhaul for propellers required to be overhauled on a specific time basis, for each propeller. A propeller logbook is an appropriate document for recording total time in service and time since overhaul. In some cases, lack of records may require premature maintenance activity, overhaul, or possible retirement since most ADs presume if the time in service and time since overhaul is not known, the propeller requires compliance with the most restrictive level called out in the AD. Propeller logbooks are available from various sources, including the propeller manufacturer. Damage as well as details of maintenance to the propeller should be entered into the logbook. The total time in service and time since the last overhaul recorded in the propeller logbook should be updated at minimum at the time of annual inspection when reviewing the aircraft operating maintenance records.

**201. CLEANING.** Proper cleaning of the propeller is critical to maintaining its continued airworthiness. Care should be taken in cleaning all propeller surfaces to prevent damaging the surface being cleaned. Many propeller surfaces have finish requirements that can be damaged by harsh brushing, cleaning agents, and handling. Other surfaces have special finish textures such as shot or glass bead peening that can be harmed by abrasion or polishing with steel wool or other abrasive materials. In addition, special corrosion protection finishes such as lacquer, paint, or anodizing can be inadvertently removed during cleaning. Use of high-pressure washers is not recommended to clean propellers because the high pressure may drive water under seals and into the hub and other cavities in the propeller. Once the water enters the propeller, it can establish a corrosive internal environment. Alkaline and acidic solutions and strippers for routine cleaning should also be avoided.

**NOTE: If any oil or grease is evident on the propeller, the source of the leak should be determined before cleaning since the oil or grease may be leaking from a crack, seal, or lubrication fitting (see Figure 2-1).**

**FIGURE 2-1.**  
**Grease Leak Residues**



- a. Cleaning.** Cleaning should be done with clean water and a non-alkaline cleaner.
- b. Post-Cleaning.** Rinse the propeller with clean water, dry with a soft cloth.

**202. INSPECTION METHODS.** The methods used in propeller inspection are versions of methods used in inspecting the entire aircraft. These methods have precisely determined probabilities that, if a defect exists, it will be detected. This reliability of detection of defects permits inspection intervals to be established. To ensure that a component will remain airworthy, it is necessary that the inspection used to detect defects in that component be accurately and reliably accomplished. This process requires that all inspections of the same part on a propeller be performed in a uniform manner to ensure the appropriate probability of detection of a defect. The inspector should be trained in the method and the inspection device used should be in good condition and calibrated as required. A detailed procedure should be used. A more detailed discussion of the requirements for satisfactory inspection may be contained in the propeller manufacturer's maintenance documents. All inspections, other than visual, must be conducted in an appropriately rated repair station.

**a. Visual Inspection.** The primary defense against early failure of propellers. When inspecting propellers, it is necessary to use touch and other senses, as well as visual cues. Changes in surface roughness, unusual free play, and odd sounds give hints as to conditions that may affect airworthiness. Feel for roughness and look for small variations in color, texture changes, waviness, and changes in reflection that may signal the removal of protective coatings. Some areas may require the use of a 10x magnifying glass to identify small features or find cracking. Refer to the propeller manufacturer's maintenance documents for specific instructions.

**b. Penetrant Inspection.** Fluorescent penetrant is far superior to non-fluorescing penetrant (visible die penetrant), particularly for detecting small surface cracks on propeller blades. The use of visible die penetrant is not recommended. Cleaning is vital to ensure reliable detection and the absence of false indications. Sometimes, manufacturers recommend specialized cleaning



procedures involving media blasting and etch. Such procedures, if called for, are beyond the capabilities of most maintenance personnel and maintenance organizations not specifically FAA-certificated to accomplish them. Penetrant inspection on propellers is conducted in a rated repair station. Refer to the propeller manufacturer's maintenance documents for special instructions.

**c. Ultrasonic Inspection.** Ultrasonic inspection uses specialized equipment to send, receive, and process sound waves to detect flaws on or below the surface of the component being tested. Appropriately certified inspectors conduct ultrasonic inspections. Ultrasonic inspections are very specific and require specially designed probes and calibration standards to obtain reliable results. Ultrasonic inspections can be conducted on composites, wood, ferrous, and non-ferrous metals. Refer to the propeller manufacturer's maintenance documents for special instructions.

**d. Eddy Current Inspection.** Eddy current inspection uses specialized equipment to generate and measure an electric field that detects flaws at or slightly below the surface of the component being inspected. Eddy current inspection is conducted by appropriately certificated inspectors. This type of inspection is very specific and requires specially designed probes and calibration standards to obtain reliable results. Eddy current inspection is used on ferrous and non-ferrous metals. Refer to the propeller manufacturer's maintenance documents for special instructions.

**e. Magnetic Particle Inspection.** Magnetic particle inspection is conducted at an appropriately rated repair station. It is useful for finding cracks, inclusions, and imperfections at or near the surface of ferrous parts. Refer to the propeller manufacturer's maintenance documents for special instructions.

**203. TYPES OF INSPECTION.** The paragraphs below describe non-destructive inspection and visual inspection techniques that have been adapted to, or are unique to, the propeller.

**a. Inspection After Suspected Impact.** Propellers that have been involved in a known or suspected static or rotating impact with relatively solid objects (e.g., ground, maintenance stands, runway lights, birds, etc.) or relatively yielding objects (e.g., snow banks, puddles of water, heavy accumulation of slush, etc.) should be inspected for damage in accordance with the manufacturer's maintenance manual before further flight. If the inspection reveals one or more of the following listed indications, the propeller should be removed and sent to an appropriately rated repair station.

- (1) A bent or twisted blade.
- (2) A blade that tracks out of limits.
- (3) A loose blade in the hub for blades that are not normally loose in the hub.
- (4) Any noticeable or suspected damage to the pitch change mechanism.
- (5) Any diameter reduction (tip damage).

- (6) A tracking alignment error.
- (7) Visible major damage such as nicks, gouges, corrosion or cracks.
- (8) Operating changes, such as vibration or oil or grease leak

**b. Propeller Tracking Inspection.**

(1) Evaluating propeller blade tracking can indicate much information about propeller condition. Accurate propeller tracking requires securing the aircraft in a stationary position and ensuring that the engine propeller shaft is tight against the thrust bearing. A blade-tracking datum can be made simply by placing a block on the ground in front of the aircraft in the propeller arc. Raise the block as required to obtain a clearance between the blade tip (blade vertical) and the datum block not exceeding 1/4-inch. Another method is to raise a block in front of the propeller with a small gap. A cowling fixture can be used as well. In some aircraft, it may be necessary to relieve engine compression (loosen spark plugs) and seek a calm day to eliminate outside disturbances that would cause an apparent tracking error. Draw a line on the block next to the blade tip position. Move the blade in a fore-and-aft direction and mark the limits of such motion. Pull all the blades past the drawn datum, checking fore-and-aft free play as before. No blade should deviate more than 1/16-inch from the plane of rotation, as defined by the drawn marks, unless the manufacturer's service manuals define greater limits. Record any abnormal condition in the propeller log.

(2) It should be noted that some propeller blades require centrifugal load to seat properly in the hub so propellers of this type will show a large amount of free play. Follow the manufacturer's tracking inspection instructions for these propellers. Blade-to-blade tracking difference could indicate a deformed blade. Free play differences on blades may indicate internal blade bearing, preload system, or actuating pin problems. Safety practices, such as ensuring that switches are off, or grounding the magnetos, are necessary to ensure that rotating the propeller does not cause the engine to start during the tracking inspection (see Figure 2-2). A repair station should not return propeller blades that exhibit any looseness or out-of-track conditions exceeding 1/16-inch (or the manufacturer's specification) to service without inspection/repair.



**FIGURE 2-2.**  
**Propeller Tracking (Wood Block or Cowling Fixture Shown)**

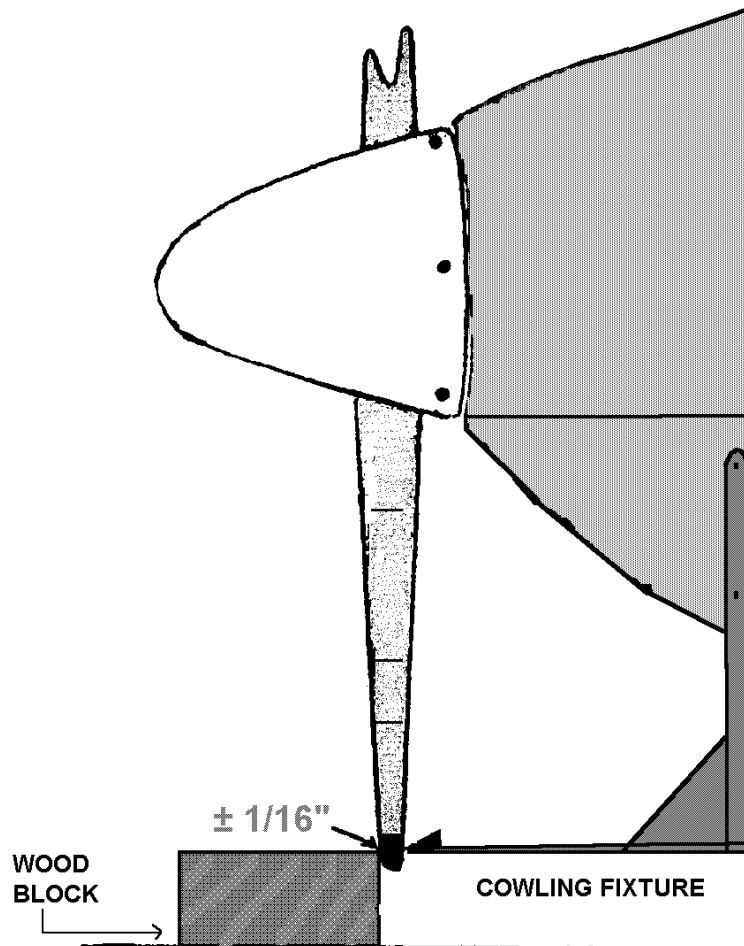

**c. Propeller Overspeed Inspection.** Generally, propeller overspeed causes no visible external damage to the propeller. In the event of an overspeed event, the manufacturer's instructions should be followed. These instructions usually contain permissible transient overspeed and overspeed limits above which the propeller must be removed and sent to a repair station. The problem that caused the permissible transient overspeed condition should be corrected since the propeller is not designed to be routinely operated at the transient overspeed limit.

**d. Inspection for Corrosion.** Corrosion may be present on the propeller in varying amounts. Prior to performing any inspection process, maintenance personnel should determine the specific type and extent of the corrosion and become familiar with the propeller manufacturer's recommended corrosion removal limitations and practices.

**e. Inspection of Aluminum Blades.** For aluminum blades, conduct a thorough visual inspection per the manufacturer's maintenance document. If blade damage is beyond that specified for field repair, the blade must either be retired or sent to a repair station for evaluation before further flight.

**f. Inspection of Composite (Including Wooden) Blades.** For composite blades, a thorough visual inspection is recommended together with a coin tap inspection of each composite blade, including the metal erosion shield on the leading edge (see AC 43-3, Nondestructive Inspection for Aircraft, or follow the manufacturer's instructions for coin tap test limits so as not to damage the blade). Repair damage, delaminations, or debonds within the limits specified. If blade damage is beyond that specified by the manufacturer for minor repair, the blade must either be retired or sent to a repair station for evaluation before further service.

**g. Inspection for Lightning Strike on Composite Blades.** Any composite blade suspected of lightning strike should be inspected and may require overhaul. Lightning strikes usually enter a composite blade through the metal erosion shield. If the blade has a metallic lightning screen or tip lightning strip, the lightning strike may enter the screen or through the tip instead of the erosion shield. If a lightning strike is present, a darkened area and possible pitting, usually in the proximity of the tip, will be noticeable. If a lightning strike is suspected or detected, follow the manufacturer's service instructions before further flight.

## 204. INSPECTION LEVELS.

**a. Three Levels of Inspection.** To ensure airworthiness, propeller inspection may be accomplished at three levels:

(1) Preflight or walk-around inspection, detailed inspection (such as a 100-hour or annual inspection), and teardown inspection (or overhaul).

(2) These levels correspond to three of the four inspection levels carried out on airframes. Regardless of the level of inspection, the inspection should follow a standard procedure to be carried out in a similar fashion every time it is accomplished. The major elements of any inspection include the following:

**(a) Basis for the Inspection.** Purpose, documents needed, inspection frequency, and what is needed to accomplish the inspection.

**(b) Preparation.** Cleaning, surface preparation, equipment and calibration requirements, etc.

**(c) Implementation.** Define what the inspection is and how it is to be carried out, defect criteria, post-cleaning, etc.

**(d) Evaluation.** Accept/reject criteria, reporting.

**b. Preflight/Walk-Around Inspection.** The propeller portion of the walk-around is an important element of the process of airworthiness maintenance. It should not be merely a superficial look, but a studied review of the condition of everything that might give trouble during the forthcoming flight.

**(1) Blade.** The blade and its surface should be carefully inspected for conditions affecting airworthiness as detailed below.

**(a) Surface Damage.** Look for surface damage on both sides of the blades such as dents, nicks, scratches, and corrosion. Surface imperfections can also be felt by running your fingernail along the blade leading edge. Damage should be repaired before flight. Whenever a noticeable dent, nick, corrosion pit, or bump is observed, an appropriately rated mechanic should blend it out. The mechanic should remove all corrosion products and determine that the section thickness has not been reduced below allowable limits. Allowable thickness limits should be obtained from the manufacturer's maintenance manual, or other FAA acceptable propeller inspection criteria.

**(b) Erosion.** Examine the blade for evidence of erosion. If metallic blades appear to show erosion beyond limits, the propeller should be removed from service and evaluated by an appropriately rated repair station. Check the condition of the paint on blades and spinners that have protective paint. Paint protects the surface of the blade from erosion, and the blade should be repaired before the paint wears through and the blade structure begins to erode. Do not apply excessive paint and do not paint propeller components unless it is in accordance with manufacturer's instructions since improper painting may affect propeller balance, operation, static electricity discharge, or have other unintended consequences.

**(c) Composite or Wood Delaminations.** Although not susceptible to corrosion like metal propellers, wood or composite propellers have special problems that can lead to an unairworthy condition. Wood or composite propellers are susceptible to internal damage from small stone strikes that can create delamination or microcracks and permit intrusion of moisture. Moisture will cause expansion of existing cracks and delaminations. When moisture freezes within the blade, it causes delamination. When inspecting wood or composite propeller blades, look for cracks or delamination on the blade surface and at blade edges. In wooden propellers, check the gluelines for debonding; look for warp and loss of protective coating (paint or varnish). If drain holes are present, it is imperative that they be inspected since they may become clogged with insects and debris. Clogged drain holes can cause moisture retention.

**(d) Straightness.** Sight down the edges to find any deformation.

**(e) Looseness.** Feel the blades and move them to find unusual changes in looseness and unusual play. Blade-to-blade differences indicate that an internal problem may exist. Some propeller blades are designed to be loose. In this case, look for blade-to-blade differences to indicate unusual play.

(f) **De-Icing System.** Check the de-ice or anti-ice boots, if installed, for good adhesion to the propeller. Examine the boots and exposed wiring for breaks and burn through (see Figure 2-3).

**FIGURE 2-3.  
Heater Edge Debond**

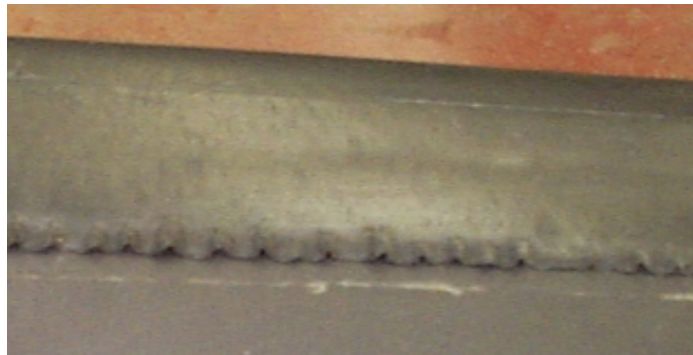

(g) **Sheath Cracks and Debonds.** Check the leading edge erosion sheath of wood or composite blades, if installed, for cracks and debonds. If damaged, repair before further flight or follow the manufacturer's recommendations for permissible limits on cracked or debonded leading edge erosion sheaths (see Figure 2-4).

**FIGURE 2-4.  
Sheath Crack**



(2) **Oil and Grease Leakage.** Look for oil or lubricant leaks in unusual places, like the outside surfaces and seals. Oil or grease leakage may be due to a seal failure or a crack. The source of the oil or grease leak should be determined before flight. During maintenance, wipe the surfaces of the propeller after this inspection, not before, since oil leaking from a crack may assist in detecting it. Some manufacturers fill hubs with red oil that gives a positive warning of a crack in the hub.

**(3) Spinner and Bulkhead.** Externally check the spinner and bulkhead for security, missing fasteners, damage, and cracks. Cracks typically originate from the attachment screws. Cracks should be serviced in accordance with the manufacturer's manuals. Check for looseness of the bulkhead. This could be an indication that the mounting bolts are loose.

**(4) General Condition.** Look for loose wires, grease fittings, and debris.

**(5) Control System.** The control system (governor) of a controllable pitch propeller should be checked to determine whether the system is operating properly and is not leaking.

**(6) Maintenance Records.** Note any indications in the logbook for future reference to determine whether a condition is getting worse.

**c. Detailed Inspection (Such as at a 100-Hour or Annual Inspection).** A more rigorous visual inspection can detect some conditions affecting airworthiness of propellers, particularly from external sources of damage, such as erosion, de-icing boot damage, and blade tracking. Many locations encountering damage are hidden. For these areas, conducting a worthwhile inspection will require some disassembly and special equipment. Such an inspection is a detailed inspection and may be accomplished in the field by appropriately rated maintenance technicians. Generally speaking, a detailed inspection requires removal of the spinner and certain other components as indicated below. Propellers suspected of more severe damage may require removal from the aircraft and the next level of inspection - a teardown inspection.

**(1) Inspection Interval.** Most manufacturers require a periodic inspection at fixed intervals, usually between 1 and 2 years or 100 to 300 flight-hours, whichever is sooner. A detailed propeller inspection is done at each aircraft annual inspection, or as required in the aircraft maintenance procedures. This inspection reduces the possibility that a propeller will be neglected and subjected to unobserved corrosion and other damage.

**(2) Fixed-Pitch Propeller.** The detailed inspection uses a procedure similar to that used in the walk-around inspection, but more time and closer scrutiny is required. Inspect the propeller section-by-section (if it is a large propeller, consider marking off sections to ensure complete coverage). Use the best possible light and use a 10X magnifier for any questionable areas. Look for cracks and corrosion pitting that may have escaped earlier scrutiny. The magnifier is a great help in determining whether a scratch is, in fact, a crack. All applicable propeller ADs must be checked for compliance. The following detailed inspections are recommended.

**(a) Propeller Blades.** Visually inspect for excessive wear and erosion, damage, nicks, cracks, corrosion, lightning strike, ground strike.

**1** Check for distortion, security to the engine, and tip tracking. Check the adequacy of protective coatings, paint, and plating.

**2** Check the leading edge erosion shield for damage, debonding, and cracks.

**3** Check composite and wood blades for delaminations, surface cracks, and exposed composite.

**(b) Spinner and Bulkhead Assembly.** Detailed inspection procedures require removal of the propeller spinner for examination of the hub area. Inspect the spinner and spinner bulkhead for cracks and repairs such as stopdrill holes and weldments. Spinner bulkhead attachment tabs frequently succumb to fatigue and should be checked. It is good practice to remove the spinner after each 100 flight-hours to observe the propeller-to-engine attachment. If repairs are present, they should conform to the manufacturer's maintenance documents.

**1** Visually inspect for cracks, wear and abrasion, loose or missing attachment bolts or screws, large dents, excessive screw hole wear, and loose or missing retaining hardware.

**2** Check cowl-to-spinner fit for damage and interference.

**(c) Propeller Assembly.**

**1** Examine propeller attach bolts for looseness, missing safety wires, and cracks. Cracked or broken bolts may be the result of overtorquing. Correct torquing procedures are given in the manufacturer's service instructions. The use of dry or lubricated bolt threads for torquing purposes is not standardized and may change from one engine to another using the same propeller. Cracks may be present in the hub area between or adjacent to bolt holes and along the hub pilot bore. Cracks in these areas cannot be repaired and require immediate removal of the propeller.

**(aa)** Visually inspect for cracks, corrosion, nicks, and damage.

**(bb)** Check the attaching bolt for improper torquing and improper safety.

**(cc)** Check the condition of fasteners, tie-wires, clips, and etc.

**(dd)** Check the adequacy of protective coatings, paint, and plating.

**2** Conduct a functional check including revolutions per minute (RPM) control, RPM limits, idle setting, responsiveness, and vibration.

**(3) Controllable Pitch/Constant Speed.** A complete detailed inspection of controllable pitch propellers requires removal of the spinner for examination and servicing of the propeller hub and blade clamp area. All inspection and servicing of the pitch control mechanism should follow the recommendations of the propeller, engine, and airframe manufacturer. All propeller ADs must be checked for compliance.

**(a) Propeller Blades.**

1 Visually inspect for excessive wear and erosion, damage, nicks, cracks, corrosion, lightning strike, and ground strike.

2 Check for distortion, looseness, and pitch tip travel.

3 Check the adequacy of protective coatings, paint, and plating.

4 Check the leading edge erosion shield for damage, debonding, and cracks.

5 Check composite blades for delaminations, surface cracks, and exposed composite.

6 Perform tip tracking procedures.

**(b) Spinner and Bulkhead Assembly.** Detailed inspection procedures require removal of the propeller spinner for examination of the hub and blade retention area. Inspect the spinner and spinner bulkhead for cracks and repairs, such as stopdrill holes and weldments. Spinner bulkhead attachment tabs and bolts frequently succumb to fatigue and should be checked. It is good practice to remove the spinner every 100 hours to observe the hub and blade retention area. If repairs are present, they should conform to the manufacturer's maintenance documents.

1 Visually inspect for cracks, wear and abrasion, loose or missing attachment bolts or screws, large dents, excessive screw hole wear, and loose or missing retaining hardware.

2 Check cowl-to-spinner fit for damage and interference that could affect propeller operation.

3 Check the security of balance weights.

**(c) Propeller Assembly.** Propeller attach bolts should be examined for looseness, missing safety wires, and cracks. Cracked or broken bolts are usually the result of overtorquing. Correct torquing procedures are given in the manufacturer's service instructions. The use of dry or lubricated bolt threads is not standardized and may change from one engine to another that use the same propeller.

1 Visually inspect for cracks, corrosion, nicks, damage, oil and grease leaks.

2 Check attaching bolt for improper torquing and improper safety ties and tabs.

3 Check the condition of fasteners, tie wires, clips, etc.

4 Check adequacy of protective coatings, paint, and plating.

**5** Conduct a functional check including RPM control, RPM limits, idle setting, ability to feather, responsiveness, and vibration.

**6** Check oil or grease for water and contamination with corrosion by products.

**7** Examine the hub area for oil and grease leaks, missing lubrication fittings, and missing lubrication covers.

**(d) Hub, Piston, Cylinder, Dome, Blade Clamps.** The hub and associated clamps, as well as pitch change mechanisms, should be inspected for corrosion from all sources, including rain, snow, and bird droppings that may have entered through spinner openings. On propeller models with blade clamps, when servicing the propeller thrust bearings through lubrication fittings in the blade clamps, the rear lubrication fitting on each clamp must be removed to avoid extruding grease past the bearing grease seal and damaging the seal. Look for water or discolored grease exiting the rear lubrication fitting. If clear or discolored water is present, it may be a sign of corrosion in the hub. Protective covers should be pressed over the ends of all lubrication fittings. Check the blade seals for leakage. Propeller domes, pistons, and cylinders should be checked for leaks at the seals and on the gas fill valve (if so equipped). Cracks may be present in the hub and retention area. Cracks in these areas cannot be repaired and require immediate removal of the propeller from further service.

**(e) Pitch-Change Mechanisms.** Fiber block pitch-change mechanisms should be inspected for deterioration, fit, and the security of the pitch-clamp forks.

**1** Check all connections and cable routings between propeller governor and cockpit control.

**2** Inspect for propeller operation, insecure mounting, binding, and restricted travel.

**(f) Feathering Mechanisms.** Certain models of full-feathering propellers use spring-loaded pins to retain the feathered blade position. Spring and pin units should be cleaned, inspected, and re-lubricated as per the manufacturer's recommendations and applicable ADs. Certain propeller models use an air charge for feathering. This should be checked for proper air pressure.

**(g) Counterweights.** Pitch change counterweights on blades or blade clamps should be inspected for security, cracks, corrosion, and to ensure that adequate counterweight clearance exists within the spinner.

**(h) De-Icing and Anti-Icing Devices.**

**1** Check the condition of rubber boots for damage, erosion, and attachment.



**2** Check the condition of the slip ring and de-ice brushes for defects, excessive wear and proper orientation.

**3** Check the condition of components, wire harness, and alcohol feed mechanism.

**4** Conduct a functional check.

**d. Teardown Inspections.** Teardown inspections may only be conducted at an appropriately rated repair station. The entire propeller is disassembled and all components are inspected for wear, cracks, etc., in accordance with the manufacturer's specifications. Teardown inspections are needed when the walk-around or detailed inspection uncovers problems that require further attention, or when required by ADs or the manufacturer's service limitations. Teardown inspections are not considered within the scope of field inspections and repairs and may only be performed in accordance with the requirements of the propeller manufacturer.

**205. LIMITATIONS.** Operational and service personnel should be familiar with the following limitations during any inspection.

**a. Corrosion.** Other than small areas of light surface corrosion with no evidence of pitting (if allowable corrosion is defined by the manufacturer), the presence of corrosion may require propeller removal and reconditioning by an appropriately rated repair station. Intergranular corrosion may be present when the corrosion protective coatings (paint, anodize, etc.) have been lost. Corrosion pitting should be removed as described in the propeller manufacturer's service documents and applicable ADs.

**b. Unauthorized Straightening of Blades.** A bent propeller cannot be straightened without special processing in an appropriately rated repair station because bending may harden the aluminum and lead to catastrophic blade failure. Careful visual inspection of the leading edges and the flat-faced portion of the blade may sometimes detect unapproved repairs. Any deformation of the flat portion such as bows or kinks may indicate previous unauthorized straightening of the blade. Sighting along the leading edge of a propeller blade for any signs of bending can also provide evidence of unapproved blade straightening. Blades should also be examined for any discoloration that would indicate unauthorized heating. Aluminum blades that have been heated for any repair must be removed from service, since only cold (room temperature) straightening by an approved repair station is authorized. All blades showing evidence of unapproved repairs require removal of the entire propeller and proper assessment by a repair station. Field service personnel should never straighten bent propellers to facilitate shipping when the propellers are being sent to a repair station for inspection and repair. This procedure can conceal important information related to the severity of the damage.

**c. Blade Shortening.** Propeller tip damage will sometimes lead field maintenance personnel to consider removing damaged material from the blade tips. However, propellers are often "tuned" to the aircraft engine and airframe resonant frequency by being manufactured with a particular diameter to minimize vibration. Shortening of the blades without reference to approved data could create an unairworthy condition, unless the manufacturer specifically

permits shortening of the blades on a particular propeller. With certain limitations, specific minor repairs may be accomplished. The manufacturer's service documents or AC 43.13-1, current edition, shows the criteria for determining whether or not a minor repair of a blade tip represents blade shortening. When conditions indicate, inspect the blade tips for evidence of shortening and, if necessary, measure the propeller diameter to determine if an unauthorized repair has altered it.

**d. Minor Blade Damage Limits.** Aircraft maintenance personnel should limit all blade repairs (except those performed at an appropriately rated repair facility) to those allowed by the manufacturer.

**e. Blade Polishing.** The FAA receives frequent inquiries from airplane owners and maintenance personnel asking whether it is acceptable to polish propeller blades. It is almost always not acceptable. Corrosion protection such as paint and anodize should not be removed from the surface of a propeller blade. Propeller blades must be maintained to the type design. If the original design had corrosion protection and the instructions for continued airworthiness call for corrosion protection, then the corrosion protection should be maintained to those instructions.

**206. PROCEDURES FOR MAINTENANCE.** Maintenance begins with the operator and includes inspection together with regular care. Many maintenance tasks that may be accomplished at a minimum cost can extend the life of the propeller and reduce or prevent costly repairs. The following is a listing of what operators of aircraft CAN and CANNOT DO.

**a. Operators Can Do the Following:**

(1) Perform a visual preflight inspection of the blades for nicks, scratches, dents, erosion, corrosion, cracks, etc. Apparent damage found should be referred to an appropriately rated mechanic. A crack or bend is cause for removal of the propeller.

(2) Check the propeller spinner attaching screws for security and check the spinner for damage.

(3) Check the propeller for evidence of oil or grease leakage.

(4) Clean propeller blades periodically using fresh water, a non-alkaline cleaner and a soft cloth or soft brush. Dry with a soft cloth.

(5) Ensure that the tachometer is appropriately marked for operational limitations of the propeller and that the tachometer accuracy is checked at periodic inspection intervals.

(6) Make sure that the applicable installation, information, and warning decals are on the propeller. These decals may include warnings against pushing or pulling on the propeller, the model number, the correct bolt torque, dynamic balancing information, and any other manufacturer's identification.

(7) Each propeller should have its own maintenance record.

(8) The operator should recondition or overhaul the propeller when it reaches the manufacturer's recommended service time limits.

(9) For safety and glare reduction for conventional single-engine tractor type aircraft, keep the blade backs painted flat black and the propeller tips painted with the appropriate colors to ensure good visibility. Repaint blades equally so that the balance of the propeller is not disturbed. Pusher props may have unique paint color requirements for good visibility for ground personnel. Refer to the propeller manufacturer's maintenance documents.

(10) Leave two-bladed metal propellers in the one o'clock position to minimize bird droppings and water being retained in the spinner. Wood propellers should be stored horizontal to prevent moisture accumulation in one blade, which would cause unbalance.

**b. Operators Cannot Do the Following:**

(1) Do not operate any aircraft after a propeller has been subjected to an impact without a thorough inspection by an appropriately rated person or repair station.

(2) Never straighten a damaged propeller. Even partial straightening of blades to ease shipment to a repair station may result in hidden damage not being detected and an unairworthy propeller being returned to service.

(3) Never repair any blade defect by welding, heating, or peening. Propeller manufacturers do not permit this because it can induce premature blade failure.

(4) Do not fill any damaged areas of metal blades with bulk-filler materials such as epoxy or auto body fillers. This prevents areas of potential cracking from being inspected. Additionally, filling a damaged area will not correct the stress risers caused by the dent or those caused by the loading that introduced the dent.

(5) Do not paint over areas of corrosion on blades. Corroded areas should be removed in accordance with approved procedures prior to applying the approved protective finish.

(6) Do not run up engines in areas containing loose rocks, gravel, or debris. Avoid quartering rear winds during ground run-up because this activity can cause damaging stresses.

(7) Do not push or pull on propeller blades when moving the aircraft by hand. Tow bars are specifically designed for this operation.

(8) Do not polish blades unless specifically permitted by the manufacturer's instructions.

(9) Never install a propeller on an aircraft unless it is a model approved by the aircraft TC data sheet or an appropriate supplemental type certificate (STC). The service history must be properly documented, and a pre-installation inspection must indicate that the propeller is airworthy.

**c. Minor Repairs of Aluminum Blades.** Limited minor repairs may be made on propellers by appropriately rated maintenance technicians either on the aircraft or when the propeller is removed. Minor dents, cuts, scars, scratches, and nicks may be removed providing their removal does not weaken the blade, substantially change weight or balance, or otherwise impair its performance. The following paragraphs give guidance on the methods for accomplishing minor repairs. Before attempting to repair a propeller blade, determine whether the propeller manufacturer has published damage limits that govern repair procedures applicable to that part. Do not attempt a repair without knowing exactly what minor repairs, if any, are permissible. For example, straightening or reforming a blade is not considered a minor repair. Manufacturers' service documents and AC 43.13-1, current edition, provide additional repair instruction.

**(1) Tools Required to Complete Minor Metal Blade Repairs Are:**

- (a) Fine-cut round and flat files.
- (b) Ten-power loupe or magnifying glass.
- (c) Emery cloth numbers 240, 320, and 600.
- (d) Crocus cloth.

**(2) Leading or Trailing Edge Damage.** Refer to the propeller manufacturer's maintenance documents for instructions on how to repair this damage. However, if the manufacturer did not publish this information, the following repairs can be made. For nicks, dents, pits, and cuts in the leading or trailing edges of blades, ensure that the bottom of the damage is removed first by rounding out and fairing in the repair only slightly deeper than the damage. Initial removal of material should be done using a fine cut file. All traces of file marks in the repaired area should be removed with number 240 emery cloth followed by polishing with number 320 emery cloth, then finished with crocus cloth or 600 grit emery cloth, and then visually inspected. An individual edge repair should not exceed a depth of 3/16-inch. The depth of repair should be greater than the depth of damage as given in Table 2-1. When repaired areas do not overlap, more than one repair may be accomplished. The repair length should be 10 times longer than the depth of the repair as shown in Figure 2-5, Techniques for Blade Repair. Refer to manufacturer's instructions for repairs aft of the leading edge sections of the blade. For damage exceeding depths shown in Table 2-1, use the specific propeller manufacturer's repair manual limits.

**TABLE 2-1.**  
**Blade Leading Edge Repair**

When Leading Edge Damage Is:	Finished Repair Depth Is:
1/32-inch	1/16-inch
1/16-inch	3/32-inch
3/32-inch	5/32-inch
1/8-inch	3/16-inch

**(3) Blade Face Surface Damage.** Refer to the propeller manufacturer's maintenance documents for instructions on how to repair this damage. However, if the manufacturer did not publish this information, the following repairs can be made. For gouges, cuts, and small dents on blade faces, ensure that the bottom of the damage is removed first by rounding out and fairing in the repair to form a saucer-shaped depression only slightly deeper than the damage. The initial repair should be accomplished by filing with a fine cut file parallel to the damage and finishing with 240 and 320 emery abrasive cloth, as in the manner of damage removal from blade-leading edges. Final polishing of the repair should be done with crocus cloth or 600 grit emery cloth. An individual repair should not exceed 1/16-inch in depth and the surface radius of curvature of the repair must not be less than 3/8-inch. Repair width should be 30 times the repair depth as shown in Figure 2-5. More than one repair is permitted when repair areas do not overlap an identical blade radius.

**(4) Blade Tip Damage.** Refer to the propeller manufacturer's maintenance documents for instructions on how to repair this damage. However, if the manufacturer did not publish this information, the following repairs can be made. For nicks, dents, pits, and cuts in the tip of blades, repair in accordance with the procedures used for leading and trailing edge repair. Any removal of the blade tip material that reduces the blade radius below the minimum specified for the propeller manufacturer's model designation and specific installation criteria is not permitted.

**(5) Cracks.** A crack in a blade may be discovered during the process of repair. Cracks found on a propeller CANNOT be repaired. The presence of a crack indicates that blade failure is virtually certain at any time. Cracks on the leading and trailing edges are especially prone to propagation. Blend outs or repairs should NEVER be attempted on these cracks. Propellers with cracks are unairworthy and MUST be removed from service and clearly identified as unairworthy.

**(6) Inspection.** Refer to the propeller manufacturer's maintenance documents for instructions on how to repair this damage. However, if the manufacturer did not publish this information, the following inspection can be performed. Prior to return to service after minor repairs, the reworked area should be inspected with a minimum 10x power lens to ensure that any sharp notches at the bottom of the damage have been removed.

**FIGURE 2-5. Techniques for Blade Repair.**

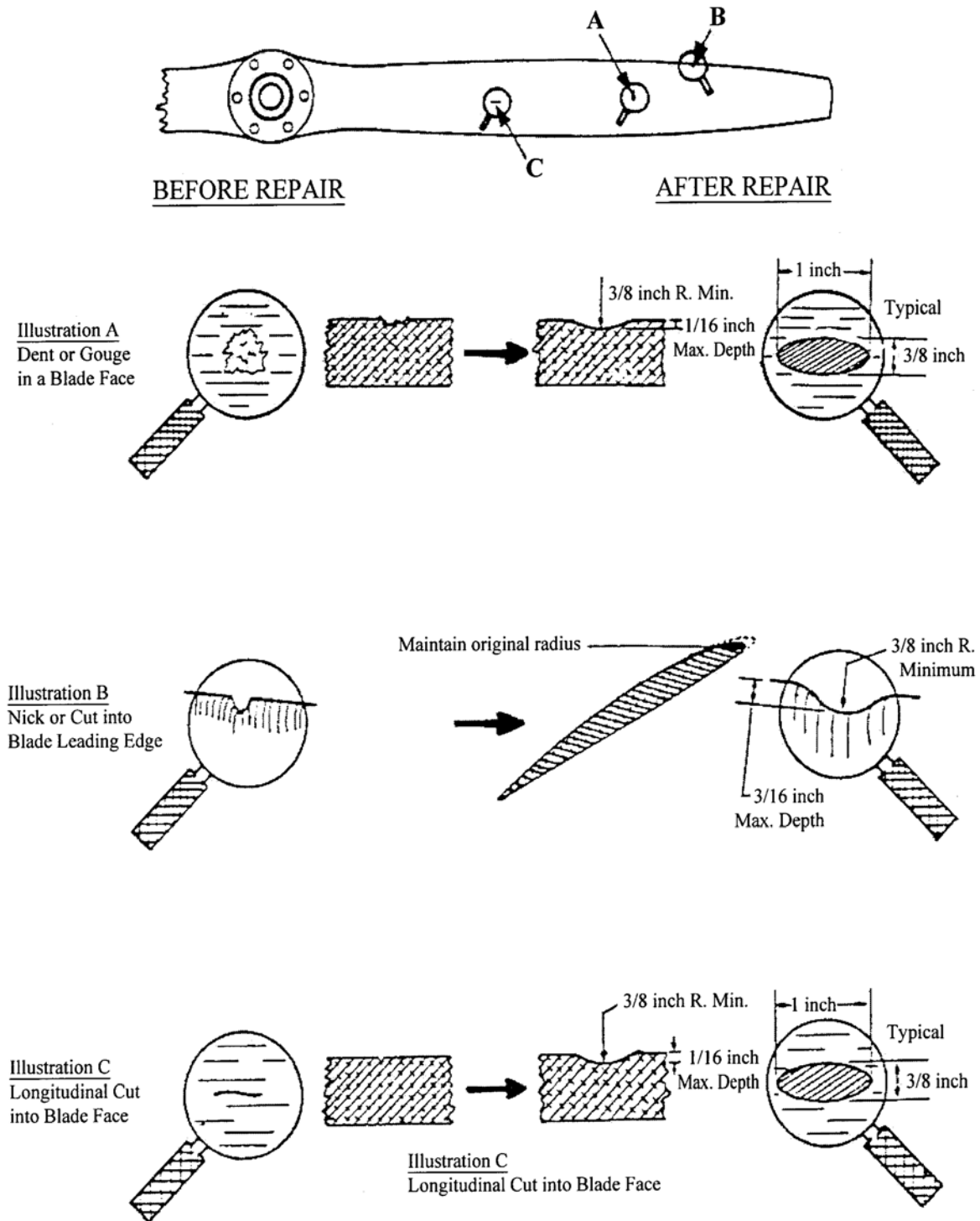

**d. Minor Maintenance of Composite Blades.** Maintenance of composite blades is permitted under some conditions. Follow the manufacturer's instructions with regard to surface preparation and cleaning. According to manufacturer's instructions, painting is permitted. The painted surface of the blade should be maintained to prevent erosion damage to the composite material. Replacement of expendable erosion strips or re-bonding peeled edges on de-ice boots is permitted in accordance with the manufacturer's instructions. Figure 2-6 shows composite blade erosion.

**NOTE: Erosion damage to the composite material may require extensive repair at a certificated propeller repair station.**

**FIGURE 2-6.  
Composite Blade Erosion**

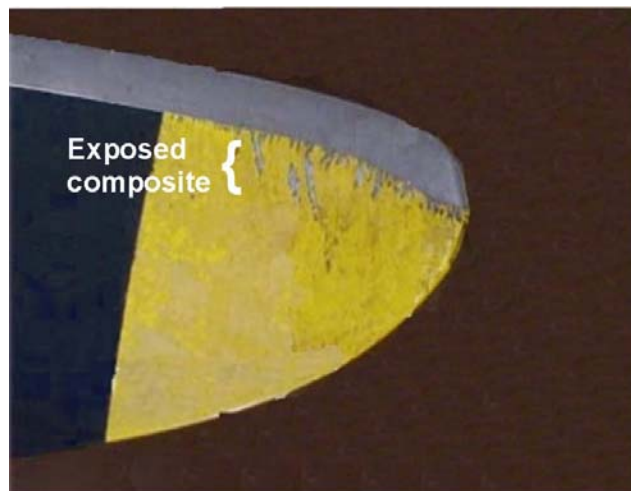

**e. Expendable Erosion Strips.** When replaceable erosion strips are installed on propellers, they should be carefully inspected for wear during walk-around inspections. If the strips lack adhesion or are otherwise damaged, they should be replaced according to the manufacturer's instructions. Addition of plastic strips without appropriate safeguards can affect propeller balance and otherwise degrade propeller performance. Ensure that all protector strips are approved by the propeller manufacturer or by STC before adding them to propellers. The application of an erosion strip on a propeller de-ice or anti-ice boot may change the ice shedding performance of the boot, and such usage must be approved.

### CHAPTER 3. ACCESSORIES AND BALANCING

**300. PROPELLER BALANCING.** This section describes only the general issues and types of propeller balancing. It is not intended to provide instructions for maintenance personnel to perform static or dynamic propeller balancing.

**a. Unbalance.**

(1) Propellers can become unbalanced during operation from mishandling, wear, damage and a variety of other causes. In some instances, the process of moving an aircraft by pushing or pulling on the propeller blades has bent or unseated the blades to an out-of-track condition or damages the blade preload system. Propeller wear and damage - and the repair of that damage - are also contributors to propeller imbalance. Unauthorized or improper repair of propeller spinners has also been identified as a cause of propeller imbalance.

(2) Unbalance results when the mass of the propeller is not symmetrical around the center of rotation. When the mass is unsymmetrical, a radial force and/or out-of-plane moment couple is formed. Static and common dynamic balance procedures only correct the radial force unbalance by adding an equal force in the opposite direction with balance weights. Only trained, specially equipped, and authorized maintenance personnel should accomplish the dynamic balance procedures.

**b. Balancing Difficulties.** Propellers that cannot be balanced or propellers that are difficult to balance on the aircraft using approved dynamic balancing procedures may have latent problems that should be investigated. Loose components, loose flange bolts, fractured components, such as hubs or blades, or blades that are out-of-track or angle, are some of the more likely problems that will cause balancing difficulties. These are problems that need to be addressed prior to further flight.

**c. Balancing Methods.** There are two methods of propeller balancing - static balancing and dynamic balancing. Neither method can replace the other because they are used for different purposes.

(1) **Static Balancing.** A propeller can be statically balanced only by removing it from the aircraft and evaluating the balance on a special fixture. Only appropriately certificated persons or organizations may adjust propeller static balance. Static balance weights are added to or removed from the propeller to correct the measured imbalance, or material from the blades is removed by special grinding techniques.

(2) **Dynamic Balancing.** Certain models of propellers may be dynamically balanced in place on the aircraft. Dynamic balancing of a propeller is done to provide for the lowest level of vibration in its operating range. Although the propeller is the focal point of the balancing procedure, it is the combination of the engine, engine mounting system, and the propeller assembly that combine to provide the level of vibration.



(a) When balance weights are added or removed from the propeller assembly, it is to reduce the level of vibration produced by the engine, engine mounting system, and the propeller as an operating assembly.

(b) When a propeller that has been balanced as part of a particular engine and engine mount system is removed from that assembly, it cannot be assumed that the dynamic balance would remain the same for another engine or engine mounting system.

(c) For aircraft or propeller manufacturers that provide procedures for dynamic balancing of the propeller in their maintenance manuals or instructions for continued airworthiness, propeller balancing is not considered a major airframe alteration.

(d) When approved aircraft or propeller manufacturer's procedures are not available, there are other acceptable dynamic propeller balancing procedures. These include, but are not limited to the Chadwick-Helmuth Publication No. AW-9511-2, entitled "The Smooth Propeller", and ACES Publication No. 100-OM-01, entitled "ACES Systems Guide to Propeller Balancing". Dynamic balancing of propellers using FAA-approved or -accepted dynamic propeller balancing procedures is not considered a major propeller repair unless the propeller static balance weights are altered or when using the Chadwick-Helmuth or ACES type documents on propeller installations of 500 horsepower or more.

(e) Install a placard on the propeller hub or bulkhead stating that the propeller has been dynamically balanced and the assembly of the power train rotating components is an indexed assembly. An entry will be made in the logbook with the date, engine hours, final balance vibration, location of the dynamic balance weights, signature and certificate number of the maintenance person.

(f) Remove any tape that is installed on the blades to conduct the dynamic balancing procedure upon completion of the balancing procedure. The tape has been known to trap moisture causing corrosion and subsequent blade failure. Dynamic balancing is done on wing and is not to be confused with static balancing. Static balancing is performed by the manufacturer or an appropriately rated repair station (see Figure 3-1).

**FIGURE 3-1.**  
**Balance Tape that was not Removed**



(g) Maintenance shall be performed in accordance with the performance rules of Title 14 of the Code of Federal Regulations part 43, section 43.13(a).

(h) The dynamic balancing procedure and the propeller's return to service must be accomplished by an appropriately rated person, in accordance with the previously stated criteria.

**301. TACHOMETER INSPECTION.** Owing to the exceptionally high stresses that may be generated by particular propeller/engine combinations at certain operating ranges, many propeller and aircraft manufacturers have established revolutions per minute (RPM) restrictions and maximum RPM limits for some models. An improperly operating tachometer can cause an engine to exceed the maximum RPM limits. Since there are no post-manufacture accuracy requirements for engine tachometers, tachometer inaccuracy could be a direct cause of propeller failure, excessive vibration, or unscheduled maintenance. Proper tachometer operation and accuracy should always be checked (using the manufacturer's procedure, if available) during normal maintenance intervals. One means of checking the tachometer's accuracy is with a commercial strobe unit through which the rotating propeller is viewed. Strobe unit controls can be adjusted until the propeller image stops in space. A reading on the face of the strobe instrument indicates the propeller's true RPM.

**CAUTION: Be aware there may be multiple false RPM solutions if the instrument sees only one blade passage.**

**302. GOVERNORS, FEATHERING, AND REVERSING MECHANISMS.** Always ensure proper operation of governors and other propeller controls. Check governor control rods periodically to ensure that they are properly lubricated according to the manufacturer's instructions and that there are no worn parts, corrosion, or leaks. For reversible propellers, the functionality of the beta lockout system somewhere on the aircraft or the cockpit should be verified before flight or in accordance with the manufacturer's recommendation. A beta lockout system is intended to prevent the pilot from inadvertently using reverse thrust in flight. The functionality of the propeller feathering system should also be verified before flight or in accordance with the manufacturer's recommendation.

**303. PROPELLER DE-ICERS.**

**a.** Propeller de-icing systems ensure safe propeller operation during icing conditions. Therefore, it is important to periodically inspect de-icer or anti-ice boots to ensure they are in an airworthy condition. Check the condition of the bond of the boot to the blade, looking for cracks and disbands. Look also for bumps, loose spots, or wrinkles in the boot. Ensure the propeller can be moved through its entire operating pitch range without placing any tension on wire leads or permitting them to interfere with or rub on nearby parts. Check for propeller resistance values between the de-icer leads and ground.

**b.** When conducting a detailed inspection, remove the spinner. Check the wiring leads and harness for looseness and wear. Ensure that wiring clamps are secure. Check slip rings and brushes for wear. Electrically isolate the de-icer circuits from other aircraft wiring, and check for intermittent open circuits by moving the de-icer straps slightly. Repairs to propeller de-icers should be made in accordance with the manufacturer's instructions. If the ice protection system uses liquid-based anti-ice boots, check the condition of the slinger-ring and the feed-tubes.

## CHAPTER 4. INSTALLATION

**400. PROPELLER INSTALLATION.** Propellers must be installed by an appropriately rated mechanic or an appropriately rated repair station. Certain propellers are only partially assembled for shipping prior to installation on the aircraft and must be assembled during installation. The propeller manufacturer will provide explicit instructions on assembly during installation that must be carefully followed. Ensure that correct seals and o-rings are used during assembly. Only the propeller manufacturer's bolt or nut torque requirements should be used for the installation. On some propellers, the correct installation torques may be shown on a propeller hub decal. Whether to use or not use lubrication during torquing is important, and the manufacturer's instructions must be carried out. When the propeller is correctly torqued, the blade track should be checked to the tolerances specified by the manufacturer's specifications. New or reconditioned propellers will be statically balanced by the manufacturer or propeller repair facility. However, if after installation, the propeller/engine combination begins to immediately run rough (vibration) on the ground or in flight, the propeller should be removed and rotated 180 degrees on the engine crankshaft (if not indexed), reinstalled, and the blade track should be checked again. Certain propeller installations may require additional dynamic propeller balancing on the engine. Chapter 3, paragraph 300 discusses the general guidelines for dynamic balancing. Proper pitch change action and RPM parameters must be checked during run-up and the installation inspected for oil and grease leaks. Spinner assemblies should be inspected during installation in accordance with the propeller or aircraft manufacturers' guidelines. Inspect spinners and backplates for warping, cracks, looseness, missing parts, fasteners, improper repairs, or unauthorized modifications (including addition of balance weights).

## **APPENDIX 1.**

### **Glossary of Common Propeller Terms**

**Blade Angle.** An angle between the chord line of a propeller blade section and a plane perpendicular to the axis of propeller rotation.

**Blade Station.** See Stations.

**Blade Track.** The path established by the tip of each blade as it passes a fixed point in rotation.

**Blade.** One arm of a propeller from the hub to tip.

**Chord Line.** A straight line drawn between the leading and trailing edges of the blade.

**Chord.** The distance from the blade leading edge to the trailing edge.

**Corrosion, Pitting.** Visible cavities extending inward from the metal surface due to chemical or electro-chemical action.

**Corrosion, Intergranular.** Intergranular corrosion occurs in the grain boundaries of some alloys of aluminum. The presence of intergranular corrosion may be the result of fatigue, stress, or the continued presence of moisture such as under a decal, or in a fastener hole. Sometimes called exfoliation corrosion, when it occurs in forgings, extrusions or rolled sheets.

**Corrosion, Surface.** Surface loss of metal due to chemical or electro-chemical action. On polished surfaces begins as a dulling of surface, soon becoming frosted, followed by widespread pitting.

**Corrosion.** Deterioration of a metal because of reaction with its environment. For further references see AC 43-4, Corrosion Control for Aircraft.

**Crack.** A physical opening or fissure within the body of a material. May be either internal within the material or at the surface (surface breaking). On a propeller, cracks can be started by cuts, nicks, or corrosion.

**Cut.** A deep, long, narrow fissure usually caused by a sharp object.

**Debond/Disbond.** An adhesive or cohesive failure or separation along a bonded interface between two or more surfaces.

**Delamination.** Separation between adjacent layers of a laminate.

**Dent.** A depression in the blade as the result of impact from a blunt object.

**Depression.** Concave surface deformation.

**Diameter, Propeller.** The diameter of the circle circumscribed by the blade tips.

**Erosion.** Surface removal of material by mechanical action of grit, sand, water, etc., usually present on the leading edge close to the tip.

**Face Surface.** Flat, or very slightly curved, side of the propeller blade against which the relatively higher pressure acts to produce thrust when the propeller is rotated.

**Gouge.** A deep groove on a blade formed by a heavy pressure contact with a solid object.

**Horizontal Balance.** The blade balance process that locates the center of blade mass along the radial direction to reduce unbalance of an assembled propeller.

**Hub.** Center section of the propeller that carries the blades and is attached to the engine shaft.

**Impact Damage.** Damage (visible or not) resulting from a blade striking or being struck, while in flight or on the ground, by an object such as a snow bank, runway light, maintenance stand, birds, etc.

**Inclusion.** Material foreign to base metal but contained in it.

**Leading Edge.** The edge of the blade that leads the direction of rotation and first encounters the air.

**Lightning Strikes.** Damage to blades caused by lightning usually manifested by localized burning, discoloration, melted metal, and/or pits.

**Nick.** A sharp notch-like displacement of metal usually found on leading and trailing edges.

**Overhaul.** Complete teardown and reassembly associated with major repair or maintenance. The terms overhaul and reconditioning are synonymous for fixed pitch propellers.

**Pitch.** The theoretical distance that the propeller blade reference station would move forward if it were moving along a helix with an angle equal to the blade section angle.

**Pitting.** Small irregularly shaped cavities from which material has been removed by erosion or corrosion. Corrosive pitting is usually accompanied by a deposit such as rust, a corrosion byproduct, formed by a corrosive agent on the base metal.

**Propeller, Constant Speed.** A propeller in which a governor is used to automatically provide constant revolutions per minute as the pilot selects the propeller pitch setting.

**Propeller, Controllable Pitch.** A propeller with blades that may be altered continuously to any desired angle during flight.

**Propeller, Fixed-Pitch.** A one-piece propeller with fixed blade angles.

**Propeller, Full Feathering.** A propeller with blades that can be rotated to a high positive blade angle to stop rotation (windmilling). This feature is common on multi-engine aircraft, because it allows an engine to be shut down and rotation stopped to reduce drag and asymmetric control forces.

**Propeller, Reversing.** A propeller in which blades can be rotated to a “negative” blade angle where they will provide a rearward thrust to slow down, stop, or move the aircraft backward.

**Propeller.** A device for propelling an aircraft that has blades on an engine-driven shaft and that, when rotated, produces by its action on the air, a thrust approximately perpendicular to its plane of rotation. It includes associated control components normally supplied by its manufacturer.

**Reconditioning.** The repair of major or minor blade damage caused by erosion or striking small objects during normal operation. Reconditioning consists of penetrant inspection, refinishing, and re-balancing. It is accomplished on an irregular basis as necessary and required.

**Repair.** The correction, on an irregular basis as necessary, of minor or major damage caused by a physical mishap. The amount, degree, and extent of damage determine whether or not the propeller can be repaired as a minor repair in the field by a mechanic.

**Score.** Groove-like indentations from rubbing by a hard, rough surface. See gouge.

**Shank.** The portion of the blade from the butt face to the first blade station.

**Stations.** Locations perpendicular to the blade center line at which dimensions are checked.

**Tip.** The portion of the blade outermost from the axis of propeller rotation.

**Tracking.** See blade track.

**Trailing Edge.** The rear edge of the blade where the air leaves the blade.